

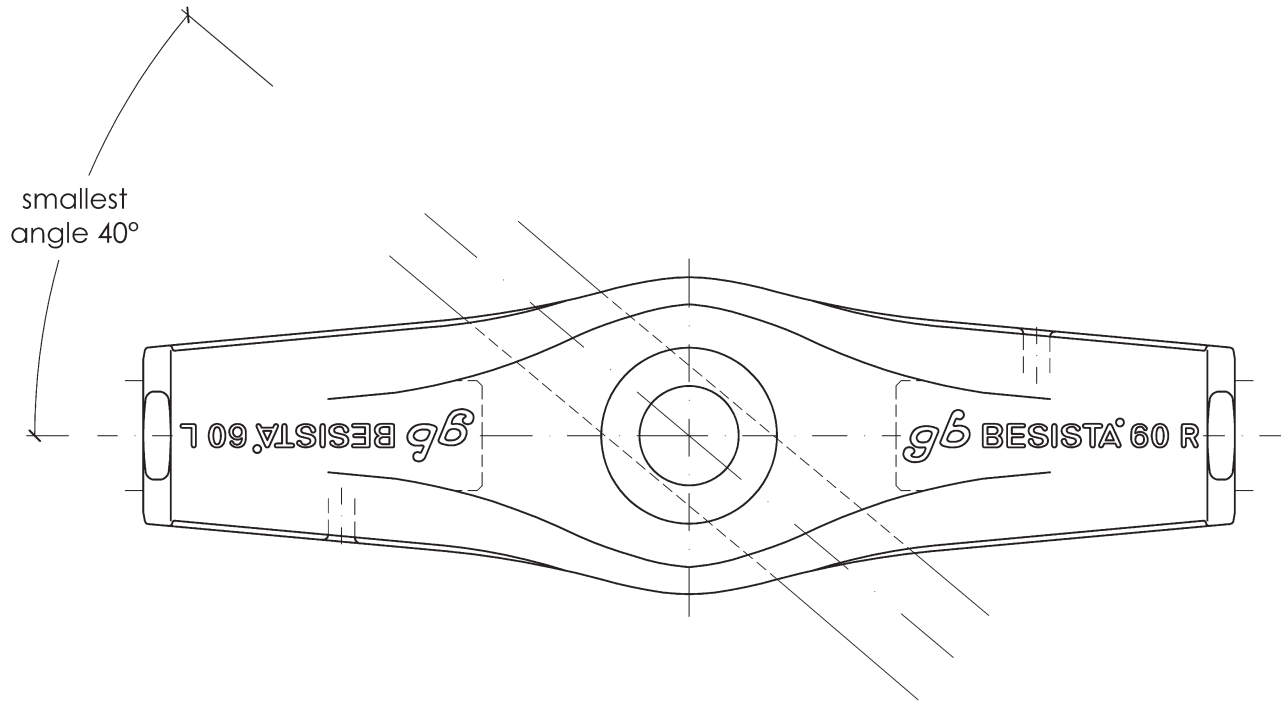

BESISTA[®] 540 - M60



© Copyright by A.P.Betschart.
 These drawings are handed over to you solely for the use of our products which are protected against improper use by industrial property rights. They are entrusted to you as defined by Section 17 UWG (German Unfair Competition Act).

